

MILANO, 12 GIUGNO 2013

UN NUOVO PUNTO DI VISTA



EPSON[®]
EXCEED YOUR VISION

MODALITÀ DI INSTALLAZIONE

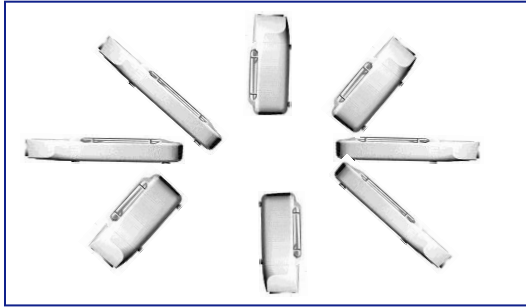

Proiezione a 360°



EDGE BLENDING

Projector 1

Projector 2



Projector 1

Projector 2

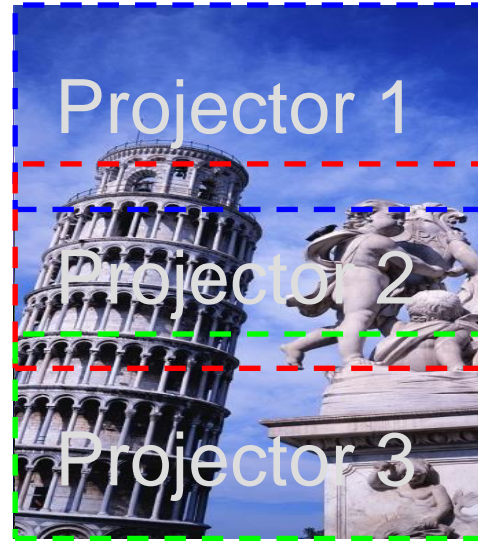
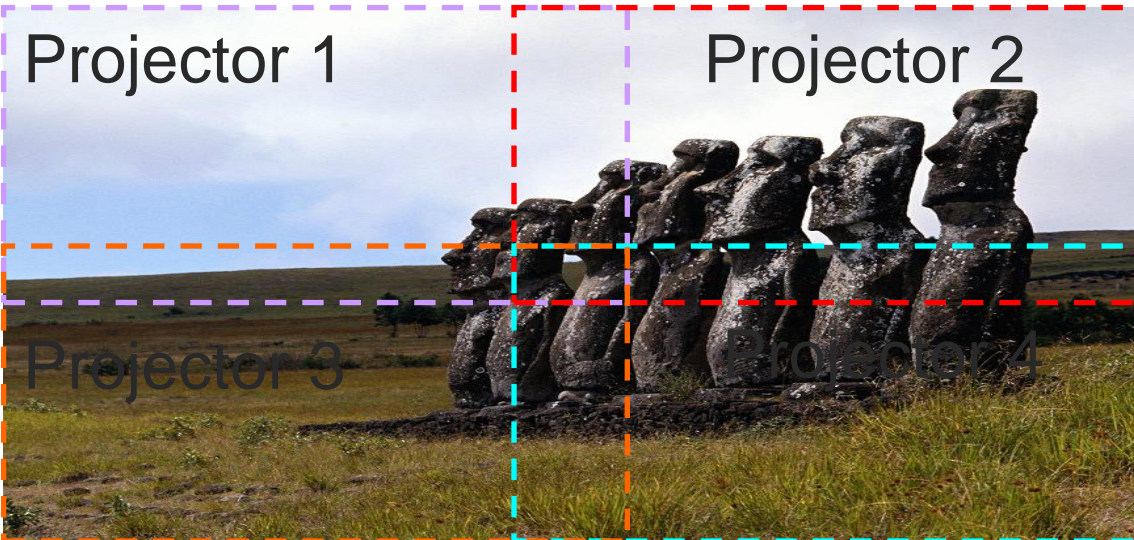

CORNER WALL FUNCTION

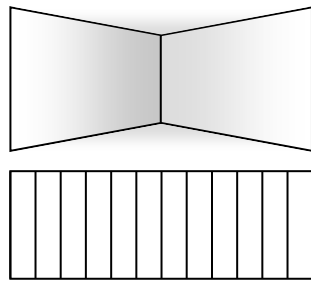
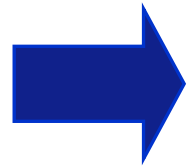
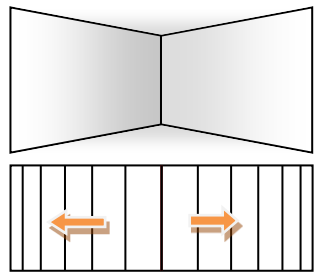
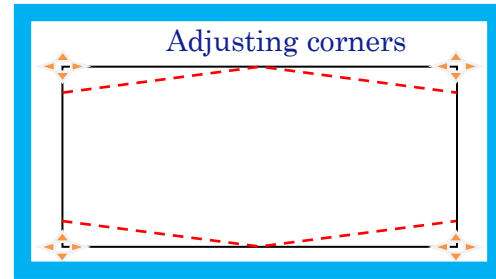
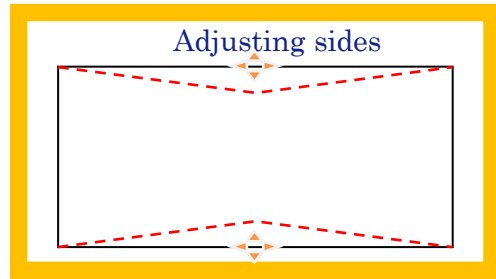
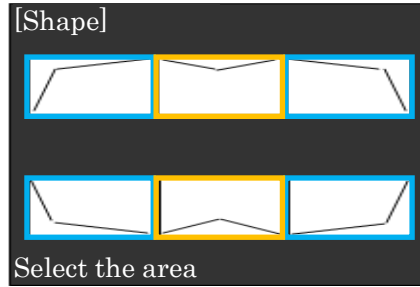

Solo
EB-G6000s Pro

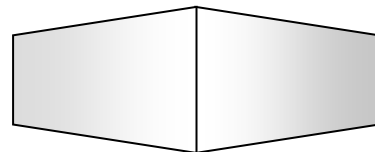
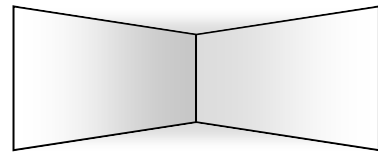
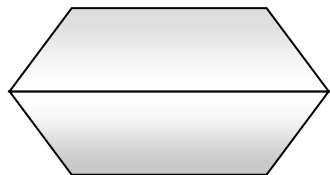
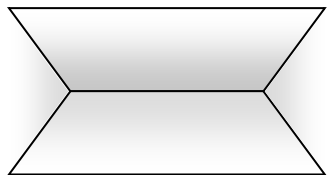

CURVED SURFACE

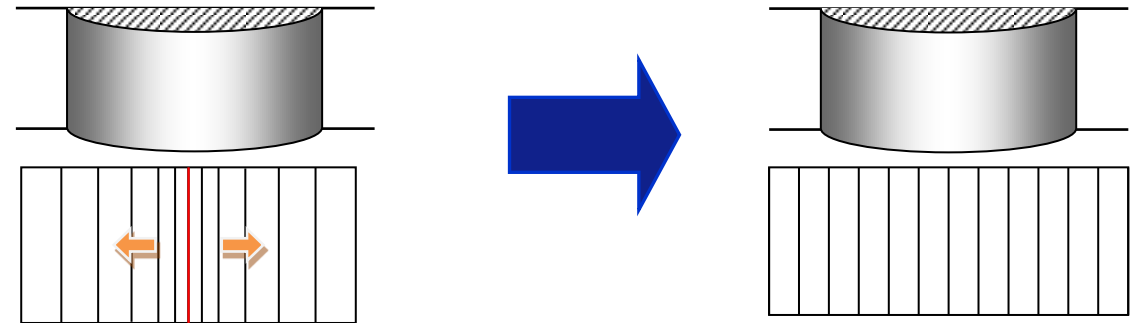
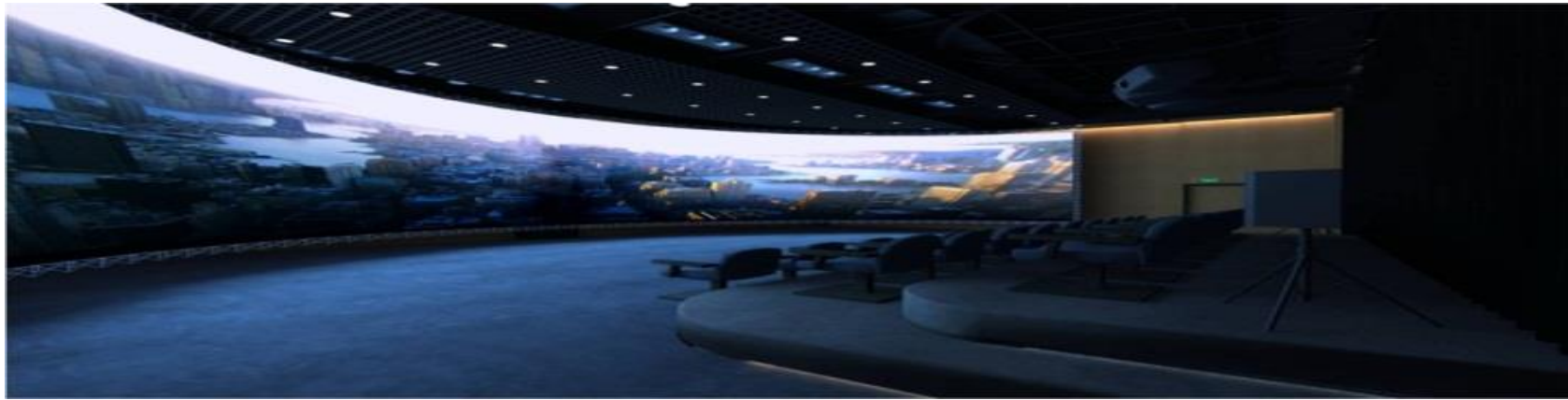
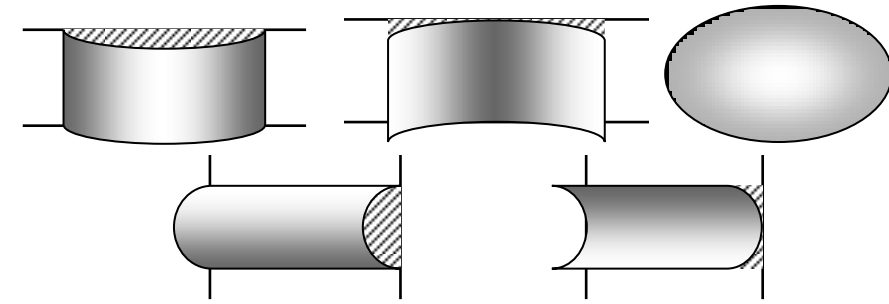
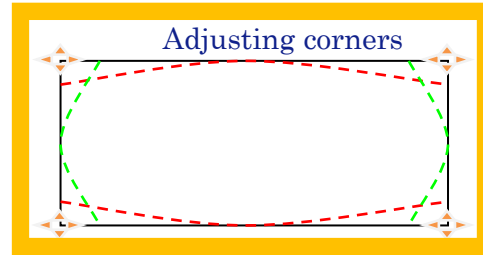
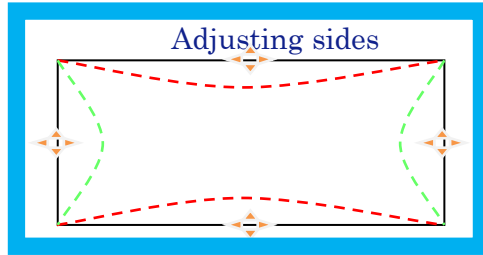
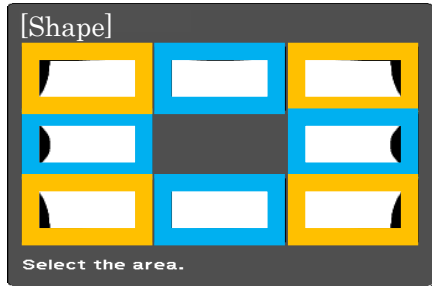

Solo EB-G6000s Pro